



Proper Alignment

Overlapping



Proper Alignment

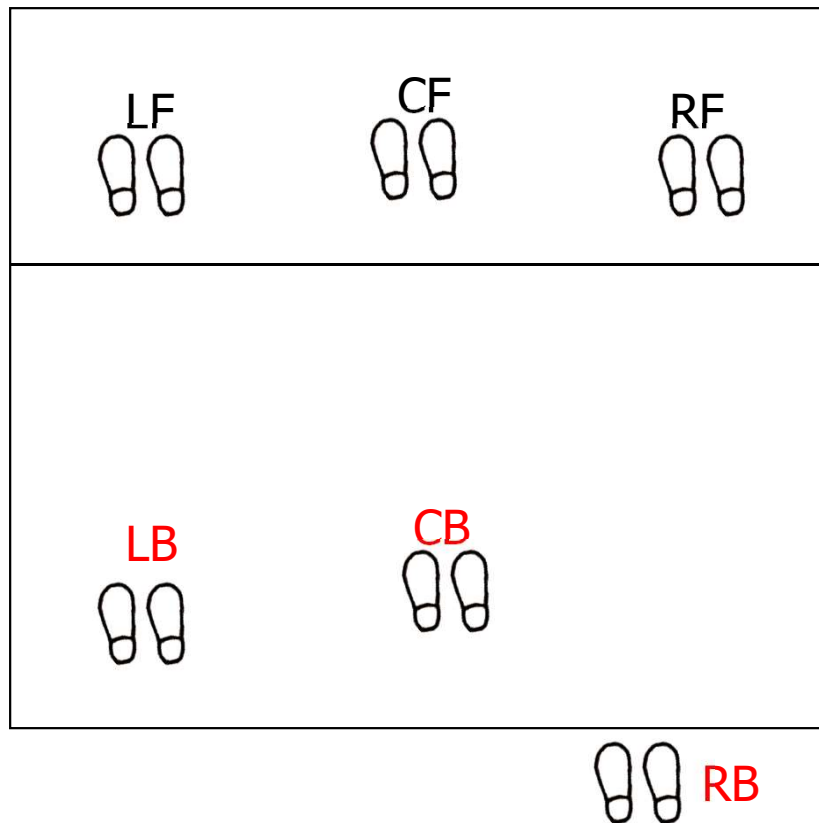

All players, except the server, are within the team's playing area and all are in proper positions



Proper Alignment

Determined by the player's foot position on the floor relative to the feet position on the floor of the adjacent player or players.

Proper Alignment

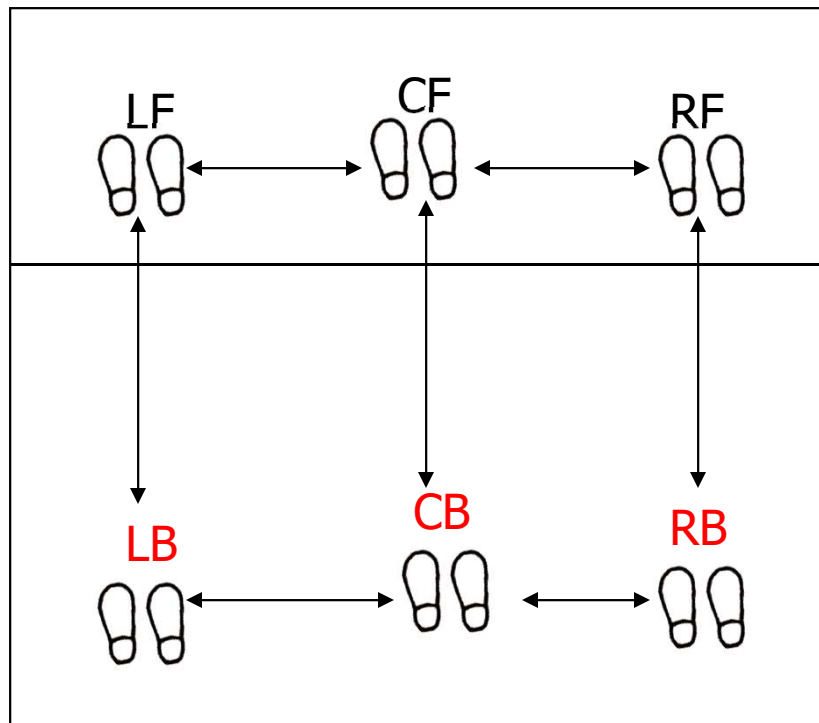

Overlapping occurs only between adjacent players; side-to-side and back-to-front



Points to Remember

Players may have any part of the body on the boundary line, but not on the floor outside those lines

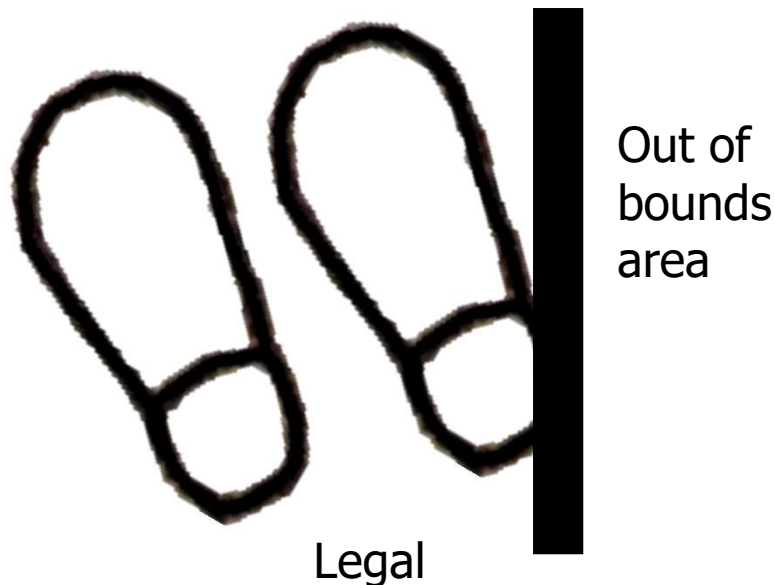



At the instant of the serve

- Each right-side player shall have at least part of one foot closer to the right sideline than both feet of the center player in the corresponding row (except the server and the center back of the serving team)

Proper Alignment (Legal)

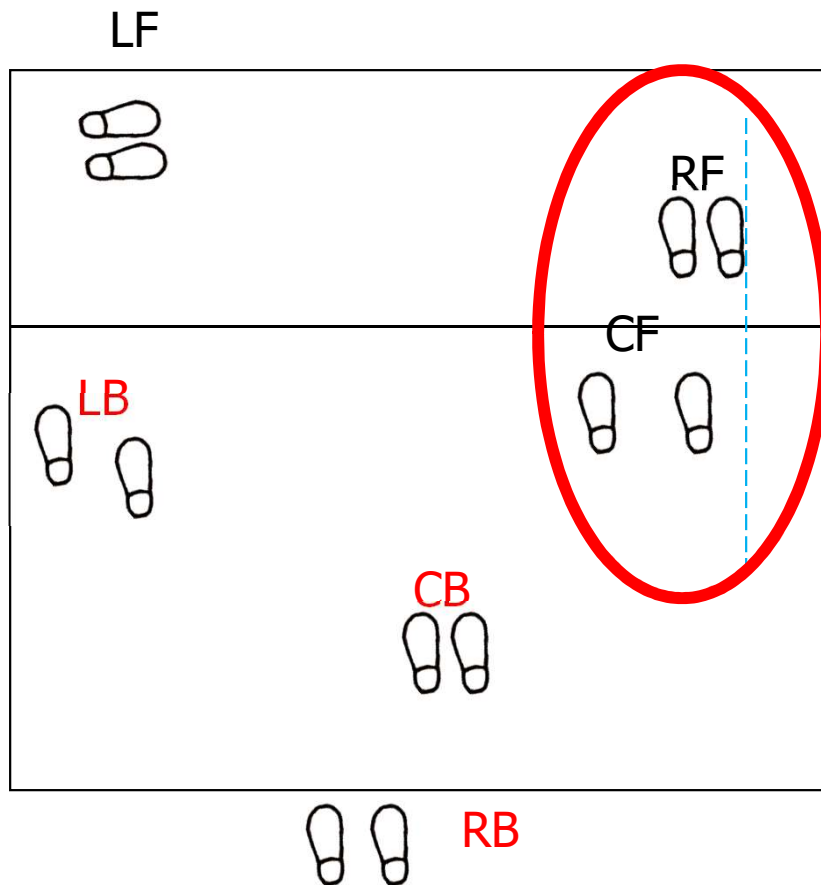

Each right side player shall have at least part of one foot closer to the right sideline than both feet of the center player in the corresponding row (except the server and the center back of the serving team)

Proper Alignment (Illegal)

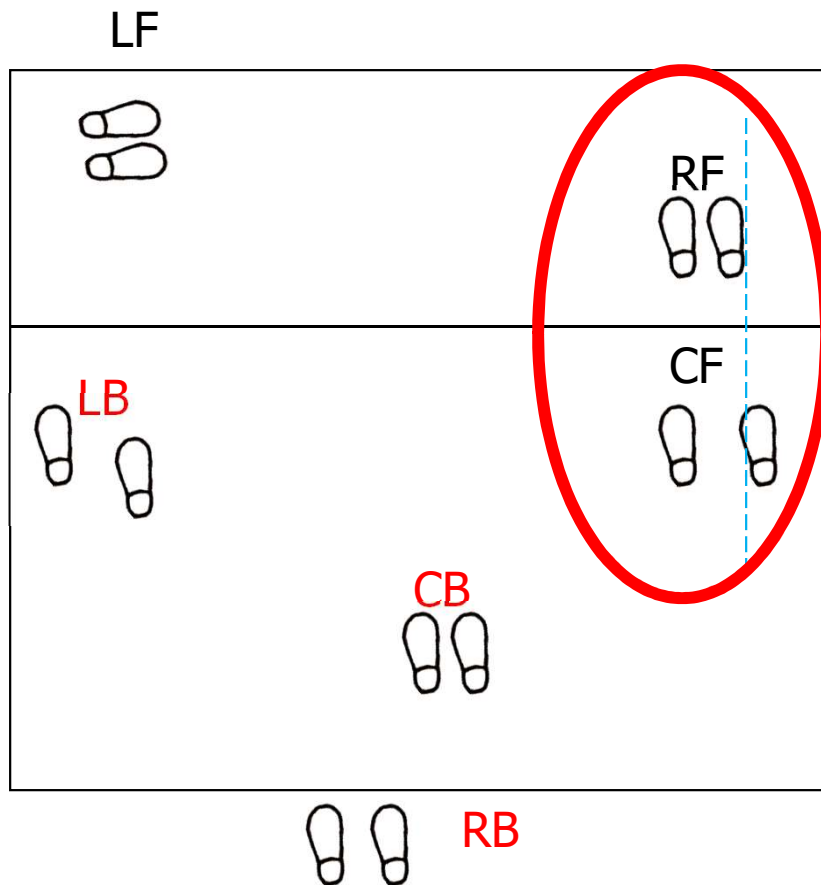

Each right side player shall have at least part of one foot closer to the right sideline than both feet of the center player in the corresponding row (except the server and the center back of the serving team)

Proper Alignment (Legal)

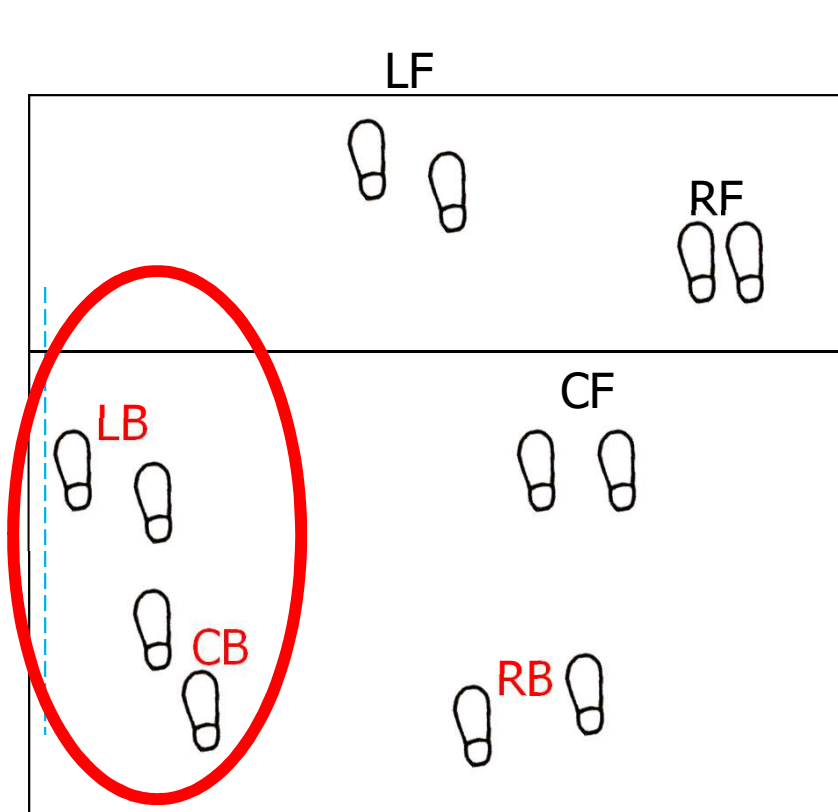

Each left side player shall have at least part of one foot closer to the left sideline than both feet of the center player in the corresponding row

Proper Alignment (Illegal)

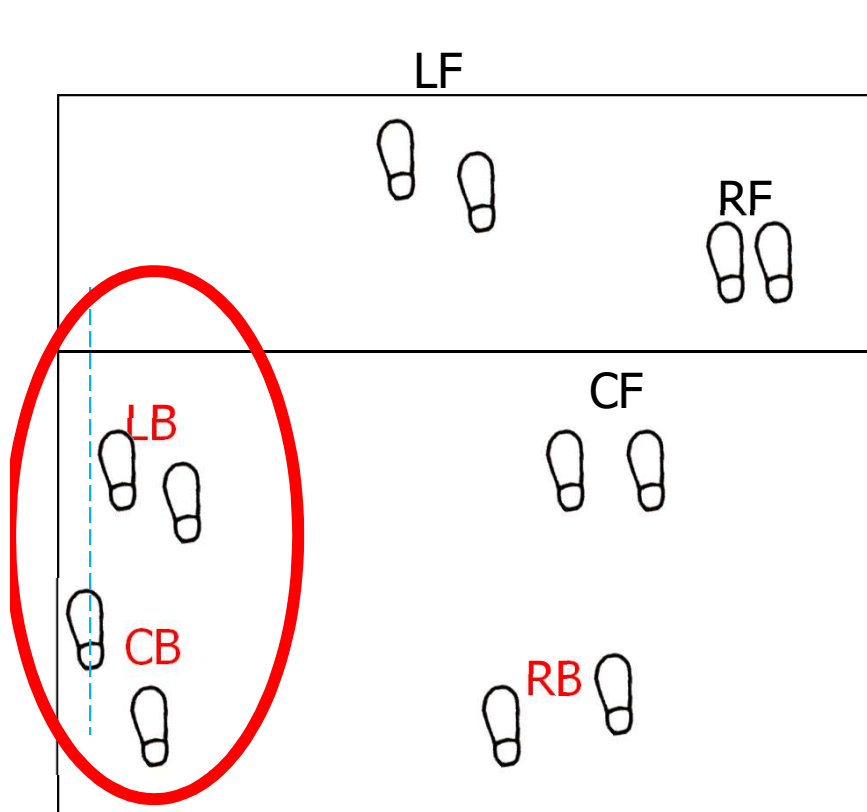

Each left side player shall have at least part of one foot closer to the left sideline than both feet of the center player in the corresponding row

Proper Alignment (Legal)

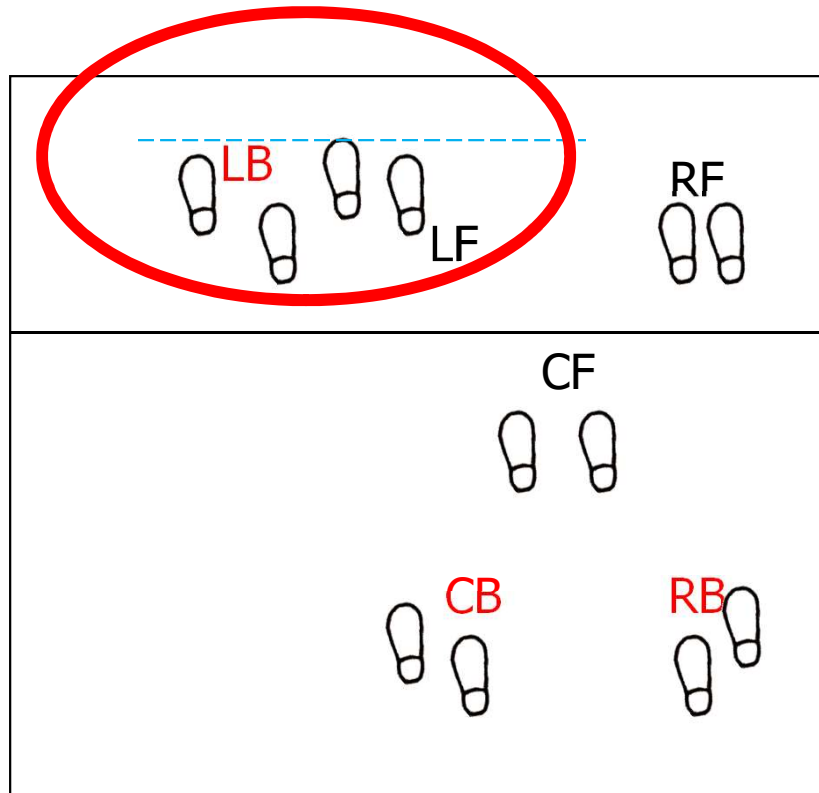

Each front-row player shall have at least part of one foot closer to the center line than both feet of the corresponding back-row player

Proper Alignment (Illegal)

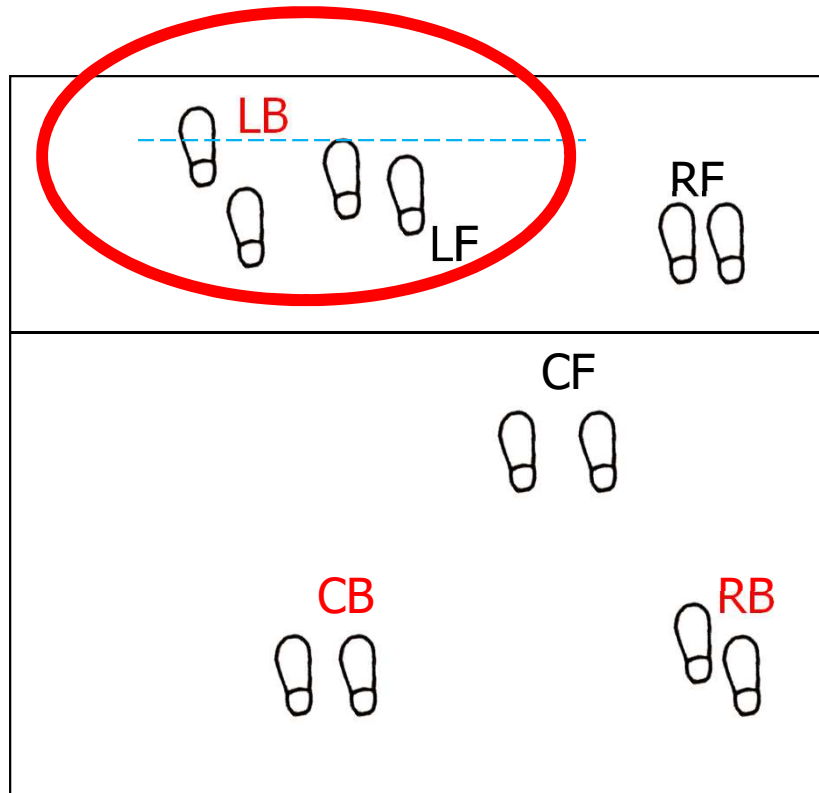

Each front-row player shall have at least part of one foot closer to the center line than both feet of the corresponding back-row player

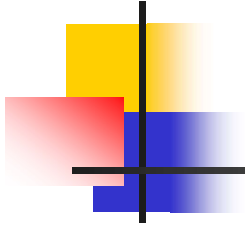

Watch for possible overlap with:

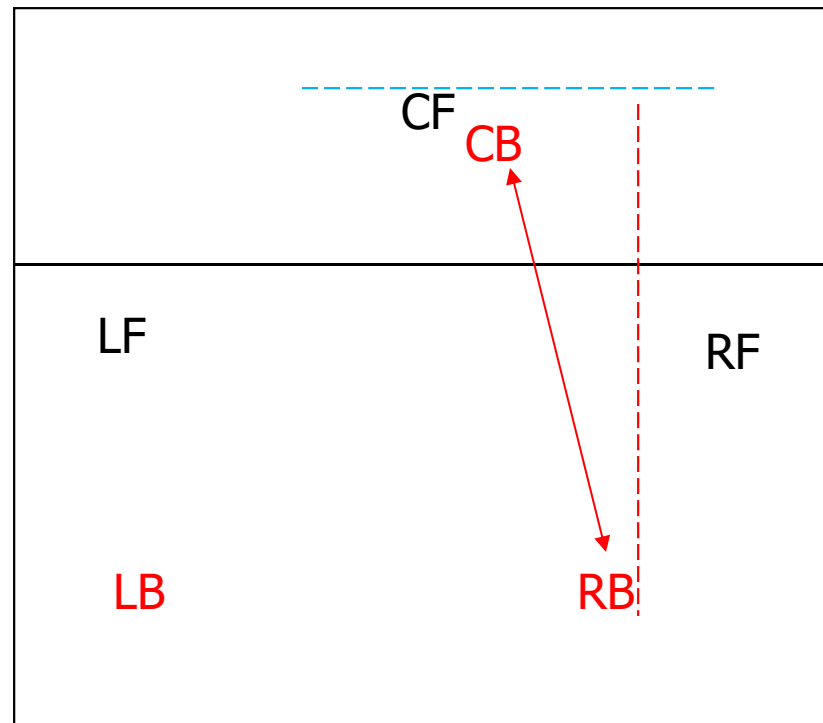

CB and RB
CB and CF

Remember RB must be closer to the
right sideline than CB
CF must be closer to the center line
than CB

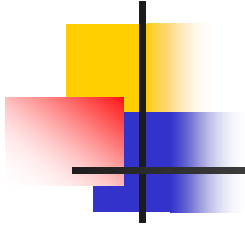

Watch for possible overlap with:

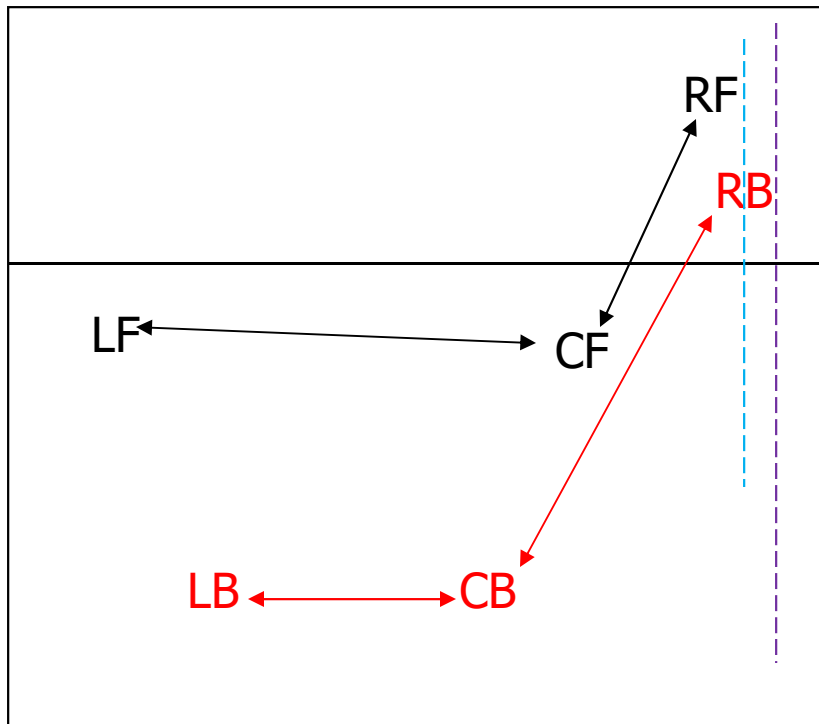

CF and RF
CB and RB

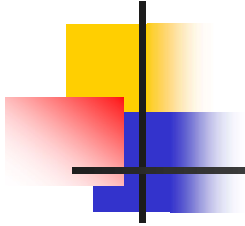

Watch for possible overlap with:

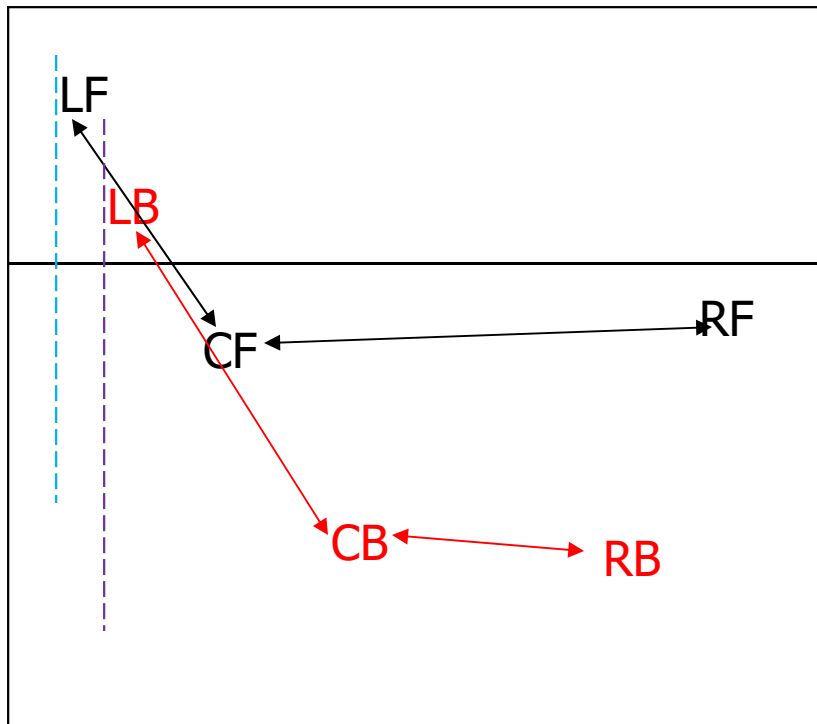

LF and CF
LB and CB
LB and LF



Situation #1

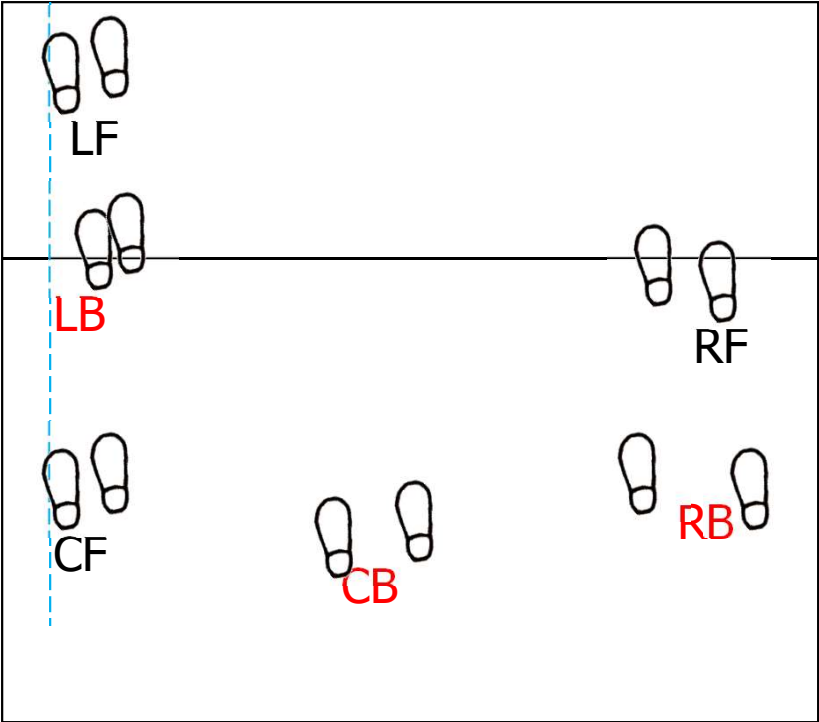

Illegal alignment or Legal?

Legal

Situation #2

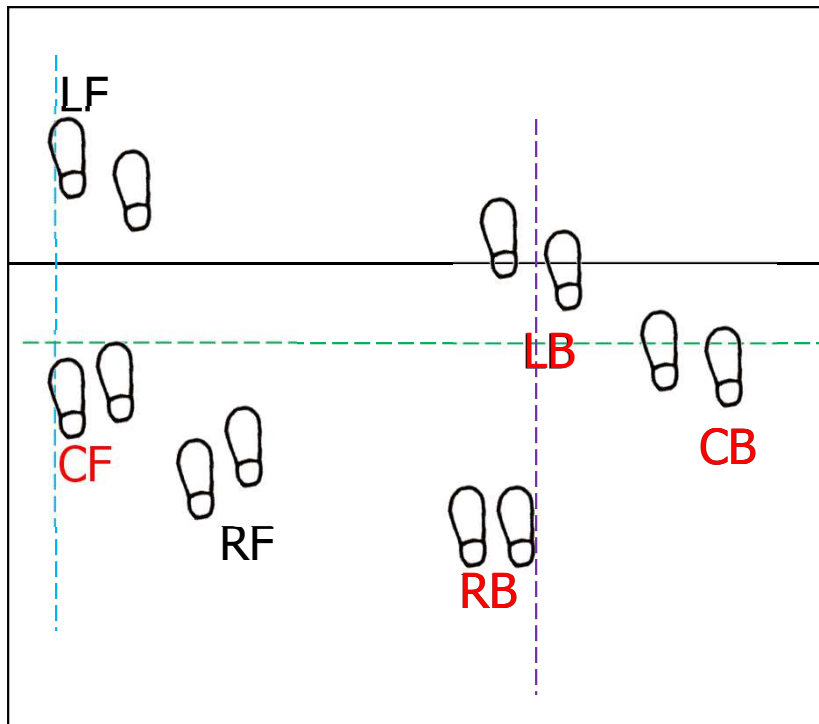

Illegal alignment or
Legal?

This looks legal

Illegal

Situation #3

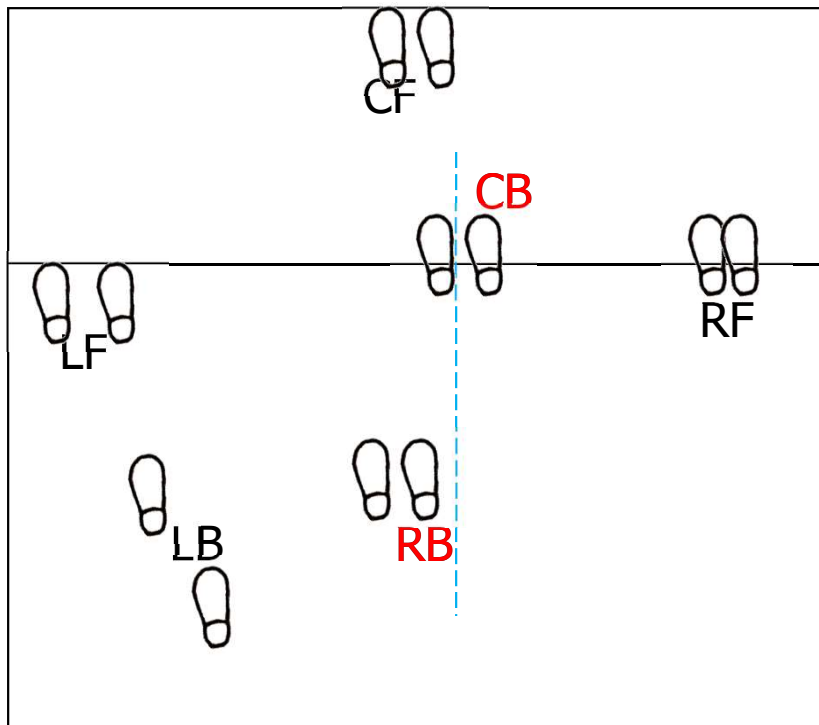

Illegal alignment or Legal?

Illegal

Situation #4

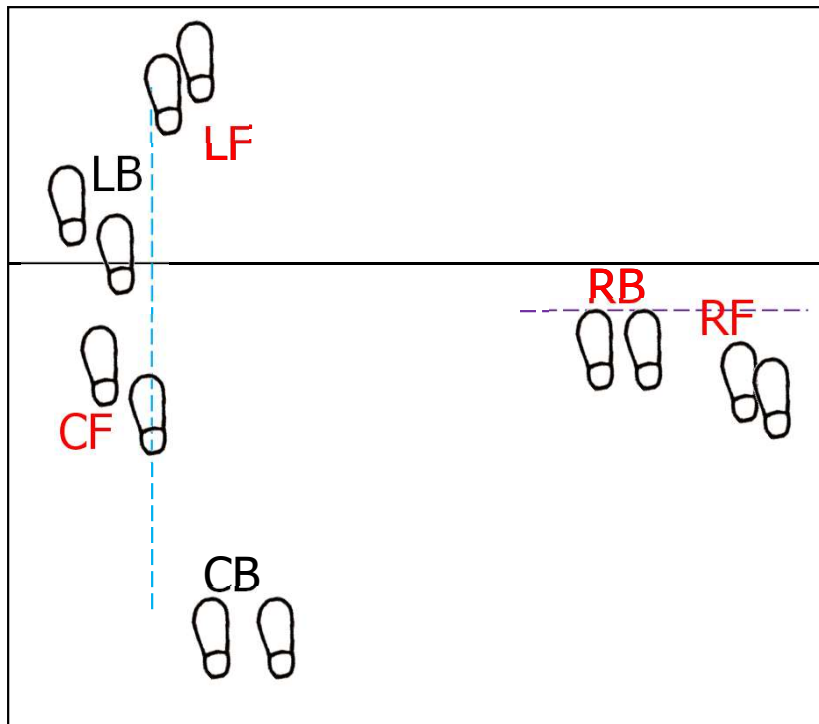

Illegal alignment or Legal?

Illegal

Also Illegal



Situation #5

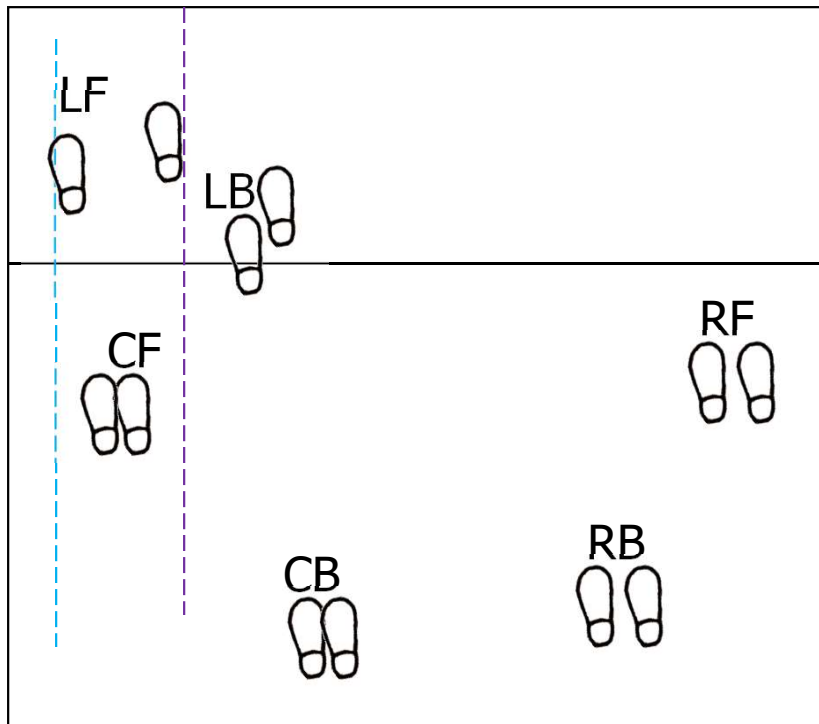

Illegal alignment or Legal?

Legal



Situation #5b

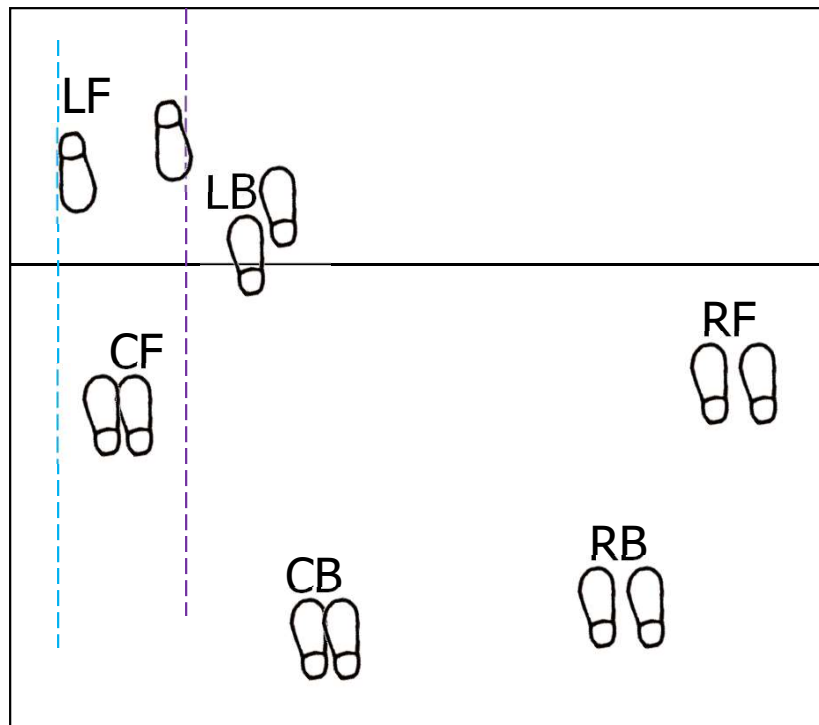

Illegal alignment or Legal?

Legal



Penalties for Illegal Alignment

- Point/loss of rally is awarded to the opponent for:
 - Overlapping by players other than the server at the moment a legal serve occurs;
 - Positioning, at the moment of a legal serve, of any player, other than the server, outside the boundaries of the playing area

How to Signal for Illegal Alignment

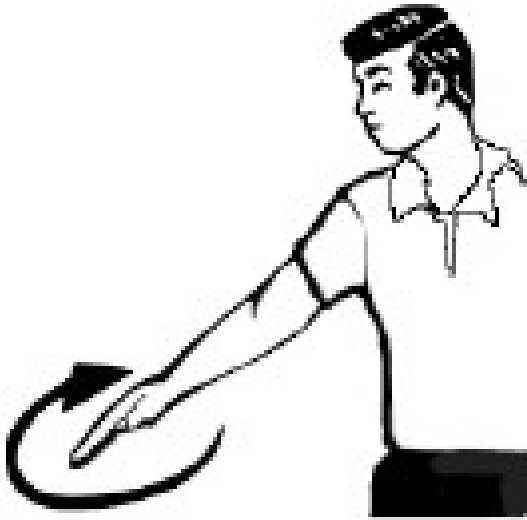

Blow whistle, step to the side of the offending team, give signal and indicate which player is aligned illegally.



Important Points to Remember

- Watch adjacent players; side-to-side and back-to-front
- Consider the foot only touching the floor when judging overlapping